











Undercounter ice maker up to 25 kg - Sprayer system

| | |
|---------------|----------------------|
| Hotel | ████████████████████ |
| Restaurant | ████████████████████ |
| Fast food | ████████████████████ |
| Bar | ████████████████████ |
| Disco | ████████████████████ |
| Fish market | ████████████████████ |
| Supermarket | ████████████████████ |
| Medical & SPA | ████████████████████ |
| Industry | ████████████████████ |

► Position n°



► Features & Plus

- Compact and crystal cube
- AISI 304 SS Scotch Brite finish 
- Possible ABS finish
- Tropical class +43°C 
- Cleanable antiscala filter 
- Air or water cooling system
- Easy cleanable internal rounded surfaces 
- HCFC-Free insulated storage 
- RoHS Free 
- Disappearing insulated door 
- Electromechanical operation 
- ON-OFF rocker switch 
- Standard and special voltages
- Patented sprayer slide



Possible ABS finish



Cleanable antiscala filter



Disappearing insulated door



Patented sprayer slide

► Available ice cube size



► Prod. 24h

| Air temp. | Water temp. | | kg | lbs |
|-----------|-------------|-------|----|-----|
| | 10° C | 50° F | | |
| | 21° C | 70° F | | |
| 10° C | 10° C | 50° F | 25 | 55 |
| 21° C | 15° C | 60° F | 22 | 49 |

2 Years Warranty
subject to limitations

► Certifications available for this model



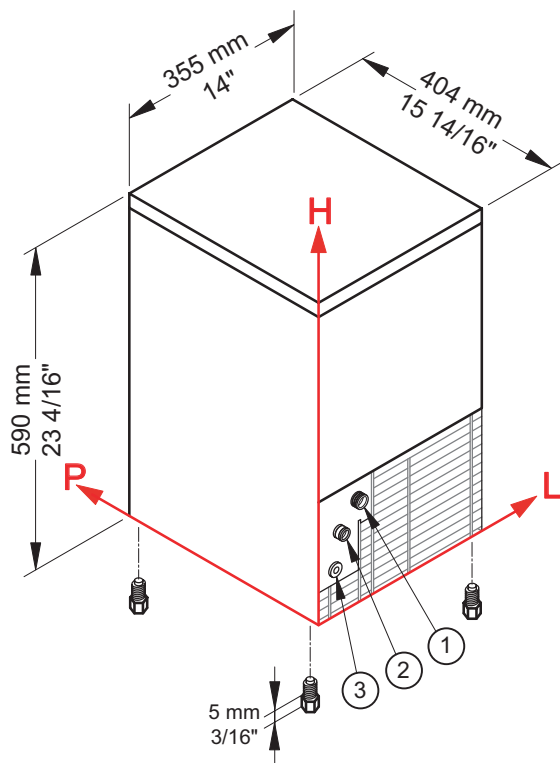

Ice Cube

CB 184**Undercounter ice maker up to 25 kg - Sprayer system****► Working conditions**

- Location: **Indoor**

| | Min | Max |
|----------------------|-----------------|-----------------|
| Ambient temperature | +10° C / +50° F | +43° C / 110° F |
| Water temperature | +3° C / +37° F | +32° C / +90° F |
| Voltage | -10% | +10% |
| Water inlet pressure | 1bar (14 psi) | 6bar (84 psi) |

► Performances

| | Water temperature | | | | | | |
|-----------------|-------------------|--------|-------|--------|-------|--------|-------|
| | | 10° C | 50° F | 15° C | 60° F | 21° C | 70° F |
| Air temperature | 10° C | 25 kg | | | | | |
| | 50° F | 55 lbs | | | | | |
| | 21° C | | 22 kg | | | | |
| | 70° F | | | 49 lbs | | | |
| | 32° C | | | | 18 kg | | |
| | 90° F | | | | | 40 lbs | |

► Connections

All measures are referred to the rear bottom-left corner (L-H-Ø)

- ① Water in.: 88 mm / 3 7/16" - 184 mm / 7 4/16" - 3/4" ② Water out.: 45 mm / 1 12/16" - 138 mm / 5 7/16" - 24 mm / 15/16"
 ③ Electrical connections: 41 mm / 1 10/16" - 73 mm / 2 14/16"

► Technical information

| | | | |
|------------------------|---|----------------------------|--------------------------------|
| Production in 24h | 22 kg / 49 lbs | Water consumption | A: 4,5 l/kg - 53,9 gal/100 lbs |
| Store capacity, up to | 4 kg / 9 lbs | | W: 20 l/kg - 239,7 gal/100 lbs |
| Cooling system | A - W | Sizes (L-P-H mm) | 355 - 404 - 590 |
| Kind of cube | D-13g | (L-P-H in) | 14 - 15 14/16 - 23 4/16 |
| Refrigerant | R404A | Sizes with pack (L-P-H mm) | 415 - 445 - 780 |
| Standard voltage | 220-240 V ~ 50 Hz | (L-P-H in) | 16 5/16 - 17 8/16 - 30 11/16 |
| Electrical consumption | 320 W | Net weight | 27,5 kg / 61 lbs |
| Fuse | 10 A | Gross weight | 34 kg / 75 lbs |
| Finish | AISI 304 stainless steel, scotch brite - ABS blue or grey | | |

All the technical information must be considered at the following conditions:

Sizes without feet
 Standard Cube (13 g)
 Ambient temperature +21° C
 Water temperature +15° C
 Electrical consumption at +43° C (standard voltage)

Models and specifications are subject to change without notice

Rev. 01 - Issued January 2016

**BREMA ICE MAKERS SPA**

Via dell'Industria 10,
 20020 Villa Cortese (MI), Italy

tel. +39 0331 434811
 fax +39 0331 433833

www.bremaice.it
info@bremaice.it

Bim + Data
download

Installation

We are Brema

