











Undercounter ice maker up to 40 kg - Paddle system

Hotel	████████████████████
Restaurant	████████████████████
Fast food	████████████████████
Bar	████████████████████
Disco	████████████████████
Fish market	████████████████████
Supermarket	████████████████████
Medical & SPA	████████████████████
Industry	████████████████████

► Position n°



► Features & Plus

- Hollow cube
- AISI 304 SS Scotch Brite finish 
- Tropical class +43°C 
- Adjustable Stainless Steel feet
- Removable and cleanable air filter
- Air or water cooling system
- Easy cleanable internal rounded surfaces 
- HCFC-Free insulated storage 
- FDA approved -ABS water basin 
- Basin tipping safety system
- RoHS Free 
- Disappearing insulated door 
- Electromechanical operation 
- ON-OFF rocker switch 
- Automatic water charge
- Standard and special voltages



AISI 304 SS Scotch Brite finish



Removable and cleanable air filter



FDA approved - ABS water basin



Disappearing insulated door

► Available ice cube size

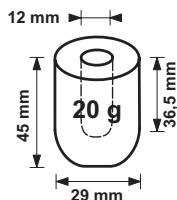

► Prod. 24h

Temp. °C	Air temp.		Water temp.		kg	lbs
	10° C	50° F	10° C	50° F		
	21° C	70° F	15° C	60° F		
					40	88
					35	77

2 Years Warranty
subject to limitations

► Certifications available for this model





Ice Finger

IMF 35



Undercounter ice maker up to 40 kg - Paddle system

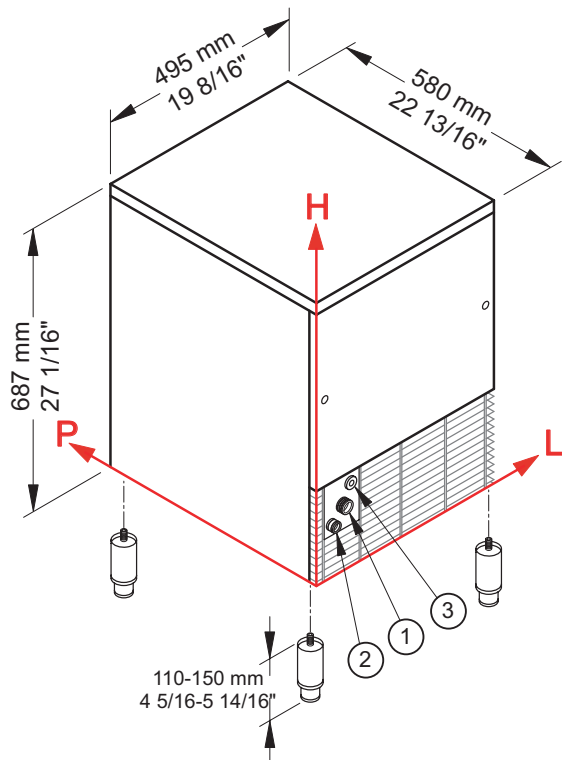

► Working conditions

- Location: **Indoor**

	Min	Max
Ambient temperature	+10° C / +50° F	+43° C / 110° F
Water temperature	+3° C / +37° F	+32° C / +90° F
Voltage	-10%	+10%
Water inlet pressure	1bar (14 psi)	6bar (84 psi)

► Performances

	Water temperature						
		10° C	50° F	15° C	60° F	21° C	70° F
Air temperature	10° C	40 kg					
	50° F		88 lbs				
	21° C			35 kg			
	70° F				77 lbs		
	32° C					24 kg	
	90° F						53 lbs

► Connections

All measures are referred to the rear bottom-left corner (L-H-Ø)

- ① Water in.: 111 mm / 4 6/16" - 196 mm / 7 11/16" - 3/4"
- ② Water out.: 49 mm / 1 15/16" - 151 mm / 5 15/16" - 24 mm / 15/16"
- ③ Electrical connections: 156 mm / 6 2/16" - 232 mm / 9 2/16"

► Technical information

Production in 24h	35 kg / 77 lbs
Store capacity, up to	15 kg / 33 lbs
Cooling system	A - W
Kind of cube	A-20g
Refrigerant	R404A
Standard voltage	220-240 V ~ 50 Hz
Electrical consumption	310 W
Fuse	10 A
Finish	AISI 304 stainless steel, scotch brite

Water consumption	A: 4,4 l/kg - 52,7 gal/100 lbs
	W: 13,3 l/kg - 159,4 gal/100 lbs
Sizes (L-P-H mm)	495 - 580 - 687
(L-P-H in)	19 8/16 - 22 13/16 - 27 1/16
Sizes with pack (L-P-H mm)	550 - 630 - 880
(L-P-H in)	21 10/16 - 24 13/16 - 34 10/16
Net weight	47 kg / 104 lbs
Gross weight	55 kg / 121 lbs

All the technical information must be considered at the following conditions:
 Sizes without feet
 Standard Cube (20 g)
 Ambient temperature +21° C
 Water temperature +15° C
 Electrical consumption at +43° C (standard voltage)

Models and specifications are subject to change without notice

Rev. 01 - Issued January 2016



BREMA ICE MAKERS SPA

Via dell'Industria 10,
20020 Villa Cortese (MI), Italy

tel. +39 0331 434811
fax +39 0331 433833

www.bremaice.it
info@bremaice.it



Bim + Data
download



We are Brema